



**ansal**  
REFRIGERACION S.A.

Otamendi 530 (C1405BRH) Buenos Aires - Argentina

Te: (5411) 4958 2884

Fax: (5411) 4958 2886

ansal@ansal.com.ar

http://www.ansal.com.ar



**Blue Star**

**Unidades Condensadoras con Gabinete para uso Exterior de 2 a 7HP**

**M y B R22 y R404A , (-25, +15°C)**



## Características:

- \* Capacidades de 2 a 7 Hp
- \* Para aplicaciones comerciales M y B R22 / R404A - (-25°C /+15°C)
- \* Gabinetes con pintura epoxi anticorrosion
- \* Bajo nivel de ruido
- \* Accesorios incluidos:
  - ° Presostato A y B
  - ° Filtro
  - ° Válvula Solenoide
  - ° Manómetros de alta y baja con glicerina
  - ° Tubo recibidor
  - ° Válvulas de servicio

Toda la información contenida en este instructivo esta sujeta a cambios sin previo aviso.



**ansal**  
REFRIGERACION S.A.  
Desde 1946



## Media 22 (-25,+15°C)

MODELO	POTENCIA	TENSION	CAPACIDAD DE REFRIGERACION A 50Hz 35°C Temperatura Ambiente (Watts)							
			-25°C	-15°C	-10°C	-5°C	0°C	+5°C	+7.2°C	+15°C
QR44H	2HP	220-240V/1PH/50Hz	1282	2314	2910	3536	4200	4761	5322	6592
QR58H	3HP		1699	3051	3838	4675	5580	6880	7597	8658
QR3-44H	2HP	380V/3PH/50Hz	1282	2314	2910	3536	4200	4761	5332	6592
QR3-58H	3HP		1699	3051	3838	4675	5580	6880	7597	8658
QR3-74H	3.5HP		1890	3922	4877	6060	7182	8316	9193	10720
QR3-90H	4HP		2347	4486	5569	6998	8483	9813	11244	14507
QR3-112H	5HP		3218	5954	7607	8997	11447	12882	14317	17813
QR3-124H	6HP		3220	6579	8566	10664	12759	14490	16221	20116
QR3-134H	7HP		4613	7033	8739	10543	12634	14111	15589	19298

Toda la información contenida en este instructivo esta sujeta a cambios sin previo aviso.

# Media404 (-25,+15°C)

MODELO	POTENCIA	TENSION	CAPACIDAD DE REFRIGERACION A 50Hz 35°C Temperatura Ambiente (Watts)							
			35°C Temperatura Ambiente (Watts)							
			-25°C	-15°C	-10°C	-5°C	0°C	+5°C	+7.2°C	+15°C
QR44H	2HP	220-240V/1PH/50Hz	1491	2314	2910	3557	4200	4761	5322	6592
QR58H	3HP		2224	3611	4360	5261	6163	6880	7597	9277
QR3-44H	2HP	380V/3PH/50Hz	1491	2314	2910	3557	4200	4761	5322	6592
QR3-58H	3HP		2224	3611	4360	5261	6163	6880	7597	9277
QR3-74H	3.5HP		2892	4157	5137	6287	7438	8316	9194	11300
QR3-90H	4HP		3010	4486	5569	7026	8483	9863	11244	14507
QR3-112H	5HP		4317	5954	7607	9527	11447	12882	14317	17813
QR3-124H	6HP		4020	6579	8566	10662	12759	14490	16221	20116
QR3-134H	7HP		5368	7033	8739	10686	12634	14111	15589	19298

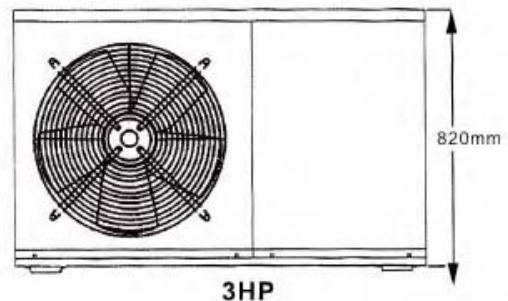
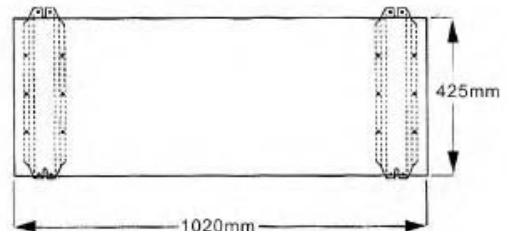
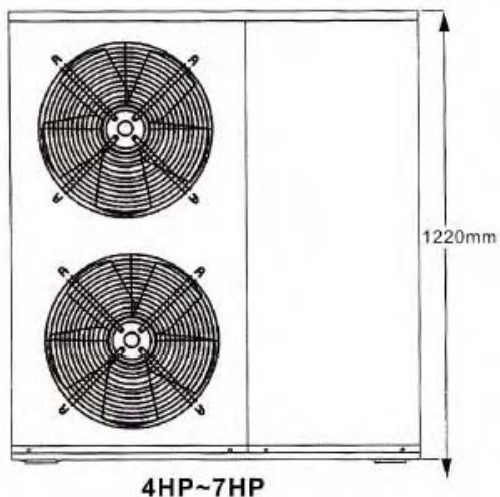
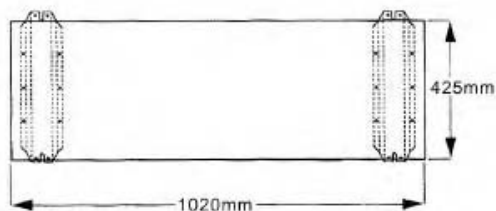
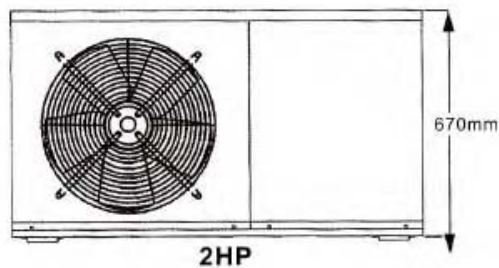
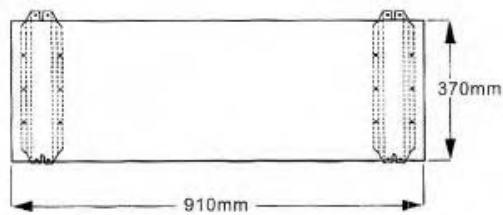

Toda la información contenida en este instructivo esta sujeta a cambios sin previo aviso.

# CIRCUIT DIAGRAM

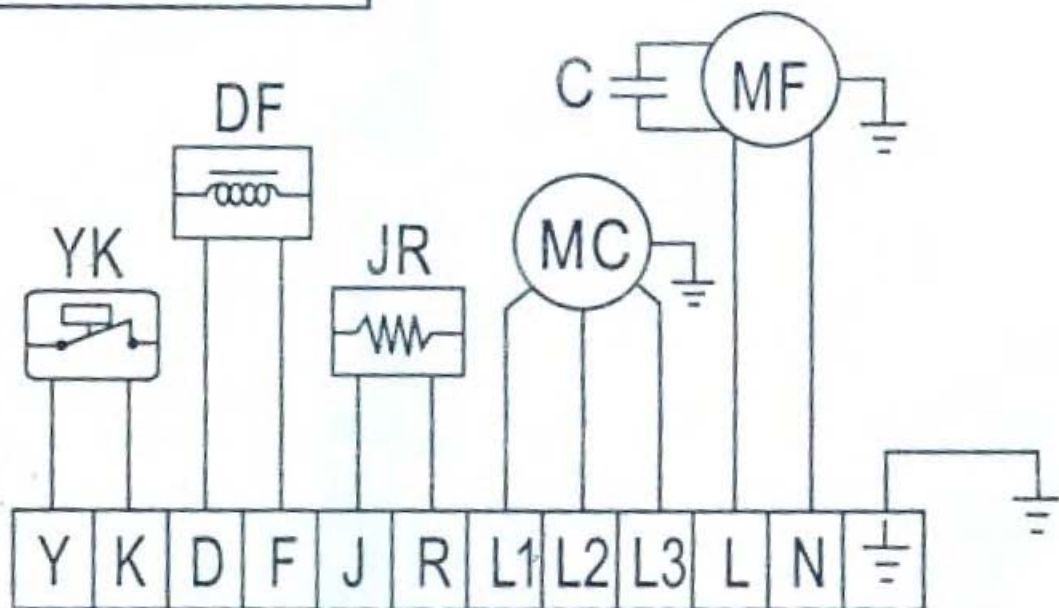

YK: PRESSURE CONTROL DF: ELECTROMAGNETIC VALVE  
JR: HEATER MC: COMPRESSOR MF: MOTOR OF FAN  
C: FAN CAPACITOR