

davica

División
**Ventiladores
Axiales**

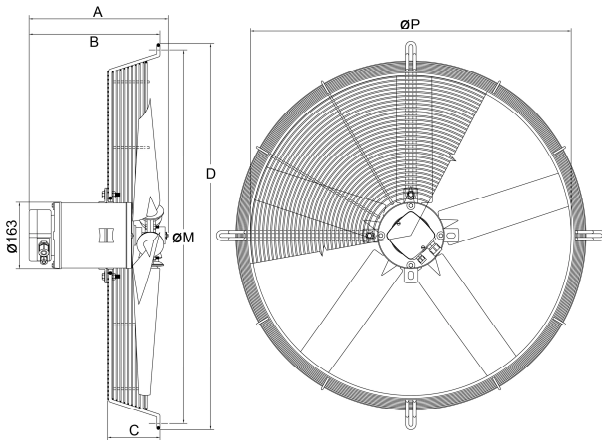

Código: R71T6T
Pala de Poliamida Vidrio
Aspirante
Ø 710 mm.
6 Polos.



Dimensiones

A	B	C	D	ØM	ØP
347	327	131	895	860	710

TRIFASICOS. Three phase

PERFORMANCE

RPM	VOLT	HZ	AMP	HP	WATT	M3/h	CURVA
910	3x380	50	2.85	1.5	1959	18600	A

